

RIO / RIO WIFI

AMBIENT TEMPERATURE & POWER REGULATOR CONTROL

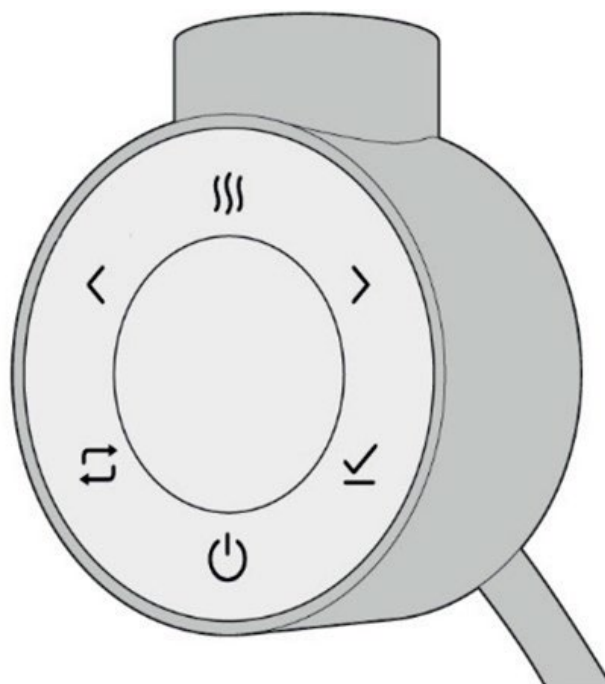

Stone Connect Wi-Fi



INSTALLATION, OPERATING AND USER MANUAL



MAY ONLY BE PERFORMED BY QUALIFIED PERSONS







nexus
easy connect



Prior to installing and using the temperature controller, please carefully read this manual and keep it for future reference

TABLE OF CONTENTS

1	General warnings 	4
1.1	Disclaimer	4
1.2	Warranty.....	4
1.3	Product compliance.....	4
1.4	General Warnings.....	4
1.5	Safety Warnings 	5
2	Product presentation	6
3	Symbols And Glossary.....	6
4	Technical Specification Tables	8
5	Installation – Qualified technicians only	9
5.1	Before you start.....	9
5.2	Towel Rail Warnings 	10
5.3	Power supply Warnings 	10
5.4	RIO / RIO WIFI position.....	11
5.4.1	TOWEL RAIL POSITION.....	11
5.4.2	SUPPLY CORD POSITION	12
5.4.3	RIO / RIO WIFI REGULATING BOX POSITION	12
5.5	RIO / RIO WIFI installation.....	13
5.5.1	IF RIO / RIO WIFI IS NOT CONNECTED TO THE HEATING ELEMENT.....	13
5.5.2	IF RIO / RIO WIFI INCL. HEAT. ELEMENT IS NOT CONNECTED TO THE TOWEL RAIL	15
5.6	Cleaning	16
5.7	Uninstalling RIO / RIO WIFI	17
5.8	Notes for disposal of RIO / RIO WIFI valid for the European Union	17
6	Use and functioning.....	17
7	Controller Functions	18
7.1	RIO / RIO WIFI buttons maps.....	18
7.2	First start	19
7.3	Standard functions ON-OFF	20
7.4	Mode selection	21
7.5	Mode editing	21
7.6	Boost mode.....	22
7.7	Weekly program edit	23
7.8	Weekly program view.....	24
7.9	Secondary functions.....	25
7.9.1	Open window.....	25

7.9.2	Timing.....	26
7.9.3	Factory reset.....	27
7.10	Lock.....	27
7.11	WIFI connection.....	28
8	Maintenance.....	29
9	Diagnostics.....	29
10	Supplied accessories, consumables and spare parts.....	29
11	Power cable size reduction.....	30

1 GENERAL WARNINGS

1.1 Disclaimer

The manufacturer declines all responsibility for any inaccuracies in this document due to printing or transcription errors. It reserves the right to make any alterations to its products deemed necessary or useful. The manufacturer will not be held responsible for faults due to incorrect installation.

1.2 Warranty

RIO / RIO WIFI is guaranteed against defects in materials and/or workmanship for a period of twenty-four (24) months from the date of purchase.

The guarantee will not be effective if the faults found are ascribable to the Buyer's carelessness and/or if the Products have not been used according to their technical specifications and in the event of wrong maintenance by non-authorized engineers, cleaning with unsuitable procedures or materials, improper storage, handling and transport, or any other circumstances that cannot be ascribed to manufacturing defects for which manufacturer is responsible.

The guarantee of RIO / RIO WIFI is not valid in case of improper use or wrong installation.

1.3 Product compliance

APPLICABLE EUROPEAN DIRECTIVES AND STANDARDS

Applicable Directives

2014/53/EU Radio Equipment Directive (RED)

2014/35/EU Low Voltage Directive (LVD)

2014/30/EU Electromagnetic Compatibility Directive (EMC)

2011/65/EU RoHS II Directive, Regulation REACH (EC 1907/2006)

2012/19/EU WEEE Directive

2009/125/EC ErP Directive - EcoDesign

Electric radiator operation is in full compliance with EN 60335-2-30

1.4 General Warnings

- Read the instructions carefully before installing and using the electronic control (hereinafter referred to as RIO / RIO WIFI or appliance) and retain the instructions for future reference.
- Installation of RIO / RIO WIFI must be performed only by qualified technicians which assume complete responsibility for the definitive installation and consequent good functioning of the product installed.
- Installation must be compliant with all applicable safety regulations and laws, national, regional, provincial and town council Standards present in force in the Country in which the

final product has been installed, as well as the instructions contained in this manual. The Manufacturer cannot be held responsible for the failure to comply with such precautions.

1.5 Safety Warnings

- Children of less than 3 years must be kept away unless continuously supervised.
- This appliance can be used by children aged from 8 years or over and by persons with reduced physical, sensory or mental capabilities or lack of experience and knowledge if they have been given supervision or instruction concerning use of the appliance in a safe way and they understand the hazards involved. Children shall not play with the appliance.
- Cleaning and user maintenance shall not be made by children without supervision.
- Children aged from 3 years and less than 8 years shall only switch on/off the appliance provided that it has been placed or installed in its intended normal operating position and they have been given supervision or instruction concerning use of the appliance in a safe way and understand the hazards involved. Children aged from 3 years and less than 8 years shall not plug in, regulate and clean the appliance or perform user maintenance.
- **CAUTION** — Some parts of this appliance can become hot and may cause burns. Precautions should be taken to ensure that prolonged contact with the el. towel rail cannot occur. Particular care should be taken in confined areas where accidental prolonged contact with the el. towel rail could be more likely to occur. Particular attention has to be given where children and vulnerable people are present.
- **IMPORTANT:** In order to disconnect the incoming supply for the purpose of isolation during installation and maintenance it is recommended for the distributor's service fuse to be withdrawn or the circuit breaker at the distribution board to be switched off whilst work is in progress.
- Do not install RIO / RIO WIFI with an electric heating element not equipped with pre-set protection devices designed to prevent over-heating of the el. towel rail in abnormal conditions.
- Do not power RIO / RIO WIFI on before it has been completely installed in a properly filled towel rail with the electric heating element recommended by the manufacturer
- Check that the electricity supply system is connected through an MCB (Magnetothermic Circuit Breaker) and a high sensitivity current differential and overcurrent relay of 30 mA RCCB (Residual Current Circuit Breaker) connected directly to the socket or connection box in use.
- If RIO / RIO WIFI is not fitted with a supply cord with a plug, an omni-pole disconnection from the supply is required, incorporated in the fixed wiring, in accordance with the wiring rules. Switches intended to ensure all-pole disconnection must be directly connected with the supply terminals and must have a contacts distance of at least 3 mm in each pole. The switch intended to ensure all-pole disconnection must be dedicated exclusively to the appliance.
- RIO / RIO WIFI is suitable for use on an A.C.~ electrical supply. Before installation check that the supply voltage corresponds with that marked on the electronic control.
- Do not insert metal objects or fingers or any other objects, even temporarily, into the connection areas where RIO / RIO WIFI is connected to the towel rail.
- Avoid direct contact of RIO / RIO WIFI with any chemical product or alcohol, including the liquid contained in the towel rail.

2 PRODUCT PRESENTATION

This product is an electrical / electronic component designed to be assembled, used and possibly replaced in case of failure uniquely in the specific equipment for which it is intended.

RIO / RIO WIFI is an electronic ambient temperature controller designed for regulating the thermal power (according to the ambient temperature) of an electric heating element installed in a towel rail configured for heating rooms in the home.

Any other use is strictly forbidden. The type of regulation is PI temperature regulation.

RIO / RIO WIFI can be connected to a fully electric towel radiator or a hybrid electric-hot water heater (dual fuel, central heating radiator).

3 SYMBOLS AND GLOSSARY

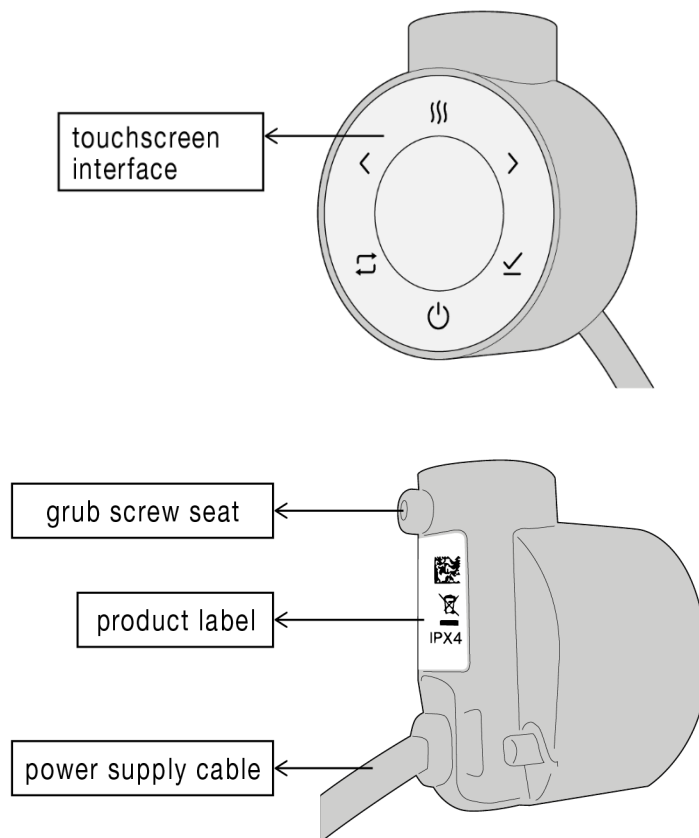

Figure 1: Components of RIO / RIO WIFI regulating box (front and back view)

Component	Description
Touchscreen interface	Capacitive touchscreen interface displaying current system status (in black or white)
Grub screw seat	Position of the grub screw in order to fix RIO / RIO WIFI to the Electric heating element connection
Power supply cable	230 V power supply cable with plug or without plug

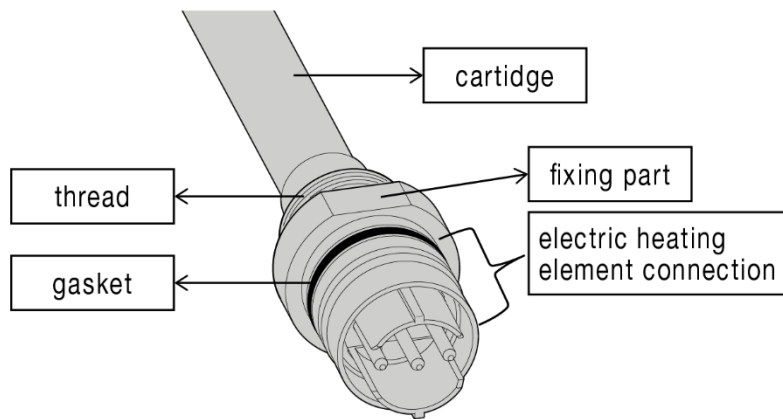



Figure 2: Electric heating element components

Electric Heating Element Component	Description
Cartridge	Heating part of the electric heating element
Thread	Connection part to be fitted into the towel rail
Fixing part	Necessary part to tighten the electric heating element into the towel rail with a 25 mm wrench
Gasket	O-ring gasket designed to be compressed between the electric heating element connection and the upper plastic part of the RIO / RIO WIFI in order to prevent water leakage
Electric heating element connection – Nexus connector	part necessary for coupling with RIO / RIO WIFI (and other compatible controllers with Nexus Easy Connect)

STANDARD PROVIDED KIT

Element	Description	
<p>O-Ring gasket</p> <p>Grub screw</p> <p>Allen key</p>	<p>22mm x 1mm gasket designed to allow RIO / RIO WIFI coupling with the electric heating element connection part</p> <p>A headless screw having a socket for a hexagon Allen key used to secure the plastic housings of the RIO / RIO WIFI onto the electric heating element connection, into the <i>grub screw seat</i> (Figure 1)</p>	

4 TECHNICAL SPECIFICATION TABLES

RIO / RIO WIFI and the electric heating element power must be carefully selected in proportion to towel rail size and thermal output. To select RIO / RIO WIFI and the heating element electrical power, please refer to the towel rail manufacturer instructions, when a certification related to the complete system (according to EN 60335-2-30) issued by an European recognized institute (like SEMKO, VDE, IMQ...) is available. The installer shall verify that RIO / RIO WIFI System operates in conformity with Table 2.

Electric heating element

Power (W)	200	400	600	800	1000	1200
Length (mm)	320	480	680	820	980	1150

Table 1

RIO / RIO WIFI	
Power supply	230 V / 50 Hz
Electric Heating element power	200 ÷ 1200 W
Insulation class	Class I
Colours and finishing	White or chrome
Touch interface display	White or black
Dimensions	61.5 x 70 x 50 mm
Water protection rating	IPX4

Maximum altitude above sea level	2000m
Operating ambient temperature	0°C ÷ 40°C
Storage temperature	-20°C ÷ 70°C
Max Humidity Level	RH 85% at 25°C (without condensation)

Table 2

5 INSTALLATION – QUALIFIED TECHNICIANS ONLY



ALL ELECTRICAL INSTALLATION WORK MUST BE CARRIED OUT BY A QUALIFIED ELECTRICIAN



Read the general warnings and safety warnings before installation.

IMPORTANT: Always disconnect the electricity supply from the mains during installation and maintenance. It is recommended that the fuse is withdrawn, or circuit breaker switched off at the distribution board while work is in progress (turning off the switch is not sufficient).

During installation, de-installation and maintenance, ensure working place safety until the operation is completed.

5.1 Before you start

- Avoid collisions during the handling. Do not deform RIO / RIO WIFI.
- Avoid the contact of cables and of parts of the RIO / RIO WIFI with sharpening corners and do not cause squashing.
- Do not subject the cables to traction. Do not apply concentrated pressures on the RIO / RIO WIFI surface.
- Any contact between plastic parts of RIO / RIO WIFI and chemical products or alcohol (including the water or the mixture water+ glycol inside the towel rail) must be avoided.
- Check the pack to ensure you have all of the parts listed at paragraph 3 with no visible signs of damage. Make sure that RIO / RIO WIFI parts are completely dry and have no defects. If any of the part is missing or appears damaged, you should return the device to the point of purchase.
- Check that you have the correct size of electric heating element and of RIO / RIO WIFI for your towel rail. It is essential that the correct sized electric heating element and RIO are installed in line with the recommendation stated on the packaging or instruction of your towel rail **CERTIFIED BY A EUROPEAN RECOGNISED APPROVAL INSTITUTE. IF YOU ARE NOT SURE OF THAT, PLEASE REFER TO CONTACTS SECTION.**

- When you are ready to start, make sure that you have the right tools at hand, plenty of space and a clean dry area for assembly.
- Installation must be carried out in accordance with current standards and laws in force in the country in which the system is installed.
- Before installation, never switch the RIO / RIO WIFI on to verify functioning effectiveness.
- Don't use the RIO / RIO WIFI regulating box to lean the electrical towel rail on the floor as you can damage the plastic housing and water can penetrate inside with a risk of electrical shock.

5.2 Towel Rail Warnings

- The electric radiator with regulator use is intended only for heating rooms in the home. Any other use is forbidden.
- The heating element must be fitted in the towel rail before mounting the rail to the wall.
- The towel rail has to be mounted parallel to the wall using the brackets recommended by the towel rail manufacturer.
- It is recommended to use in any installation (*Electric only* and *Dual fuel*) a self relief pressure valve (like a 3 Bar valve) on the top part of the rail in the opposite side where the RIO / RIO WIFI is installed. In case of valve intervention, it is quite normal for liquid relief and water excess to possibly reach the floor. Please, take this aspect into consideration.
- In Electric only RIO / RIO WIFI installation, fill the towel rail with certain percentage of water according to the towel rail manufacturer instructions. In case of missing instructions, we recommend to fill the towel rail approximately 90% with approximately 90% pure water and glycol mixture.
- In Electric only RIO / RIO WIFI installation the towel rail must have a sufficient air gap to allow for water expansion.
- Making sure that the RIO / RIO WIFI heating element is completely immersed in water.
- In case of *Dual fuel* installation, a T-piece of 40mm maximum length (male thread excluded) is required: we recommend to wrap a small quantity of PTFE tape around the heating element thread and the T-piece thread.
- All metallic parts of the electrical towel rail fitted with RIO / RIO WIFI and powered must not exceed the temperature limits according to the applicable standard also in case of RIO / RIO WIFI continuously powering the electric heating element.
For all other aspects, refer to EN 60335-1 and EN 60335-2-30.

5.3 Power supply Warnings

- Do not connect RIO / RIO WIFI to the power supply until the installation into a properly filled towel rail is completed.
- Make sure that the power lines are appropriate for the load required according to technical specification tables (see part 4).

- *Class / RIO / RIO WIFI* (with yellow-green wire or earthed plug) must ONLY be connected to sockets or connector blocks with earthed contacts according to national standards and wiring regulations in force
- Protect the electricity supply with an RCCB (Residual Current Circuit Breaker) device.
- The electrical heating element must be connected to a suitable electricity supply by way of the cable provided. This should be via a fused spur in accordance with the IEE Wiring Regulations. If sited in the bathroom, the Fused Connection Unit must be located out of reach of persons using the basin, shower or bath. If in doubt, consult a qualified electrician.

RIO / RIO WIFI supply cord

WITH plug

The socket and electricity supply must be appropriate for the required power. Do not use extensions.

The socket must be compatible with the RIO / RIO WIFI supply cord plug. Do not use adapters.

5.4 RIO / RIO WIFI position

RIO / RIO WIFI must be fitted into the towel rail BEFORE mounting the towel rail to the wall.

5.4.1 TOWEL RAIL POSITION

- Do not install RIO / RIO WIFI into a towel rail fitted in ZONE 0 or ZONE 1 (Zone definition IEC 60364-7-701 in Figure 3).
- The towel rail must be installed in a completely vertical wall.
- The towel rail has to be mounted parallel to the wall using the brackets recommended by the towel rail manufacturer.
- RIO / RIO WIFI is protected against water ingress according to its IPX4 degree of protection. The towel rail where RIO / RIO WIFI is fitted must be mounted inside the zone of the bathroom according to its IP degree of protection and electrical legislation in force. In case of doubt about the correct installation zone, refer to the relevant public institution.
- RIO / RIO WIFI must not be within reach of people using the basin, shower or bath.

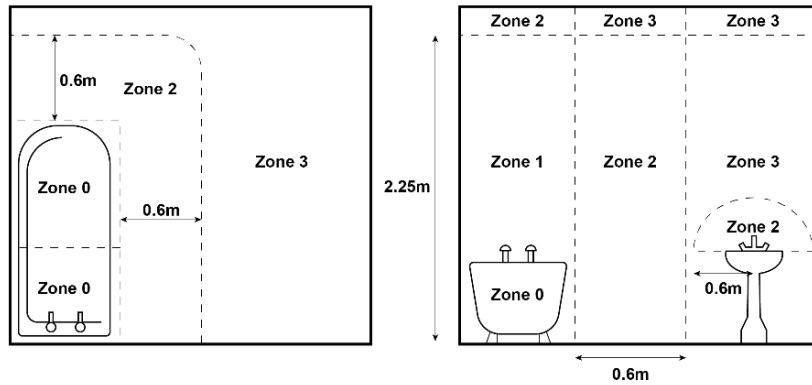

Figure 3

5.4.2 SUPPLY CORD POSITION

The supply cord must be connected to a proper socket or to a non-switched fused spur (without an intermediate plug for RIO / RIO WIFI supplied without plug) which must be at least 25 cm from the floor according to the wiring regulations in force in the country where the installation is carried out. Figure 4 shows examples of positioning of the system.

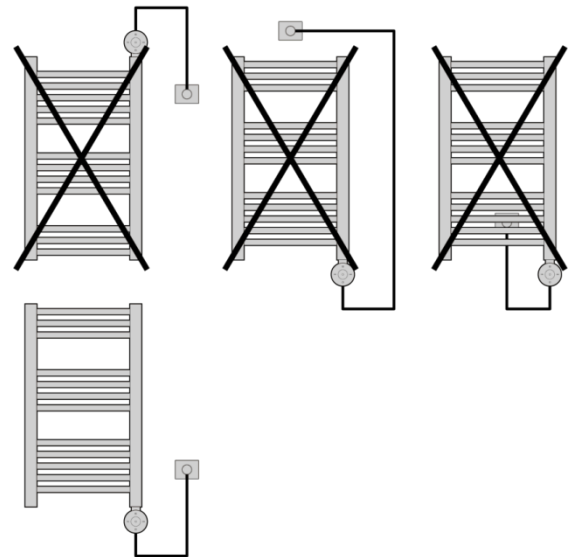

Figure 4 RIO / RIO WIFI positioning

5.4.3 RIO / RIO WIFI REGULATING BOX POSITION

- RIO / RIO WIFI must only be fitted vertically in the bottom part of the towel rail.
- Electrical towel rail must NOT be installed with the RIO / RIO WIFI regulating box located at the top. This can seriously damage the control box and create a dangerous situation with a risk of fire.
- RIO / RIO WIFI must be installed at distance of 40 mm (minimum) and 80 mm (maximum) from the wall. Figure 5 shows the optimal positions for the RIO / RIO WIFI.

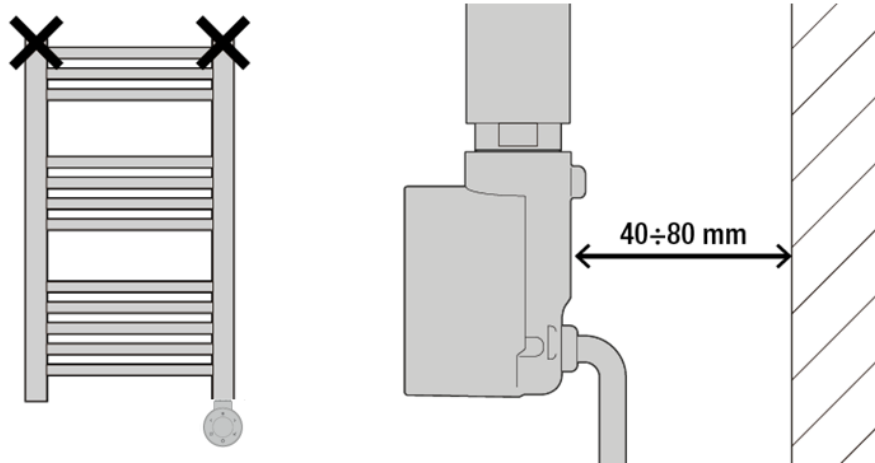

Figure 5 RIO / RIO WIFI positioning

5.5 RIO / RIO WIFI installation

ATTENTION! Be careful when handling the regulator, especially when putting it on!

5.5.1 IF RIO / RIO WIFI IS NOT CONNECTED TO THE HEATING ELEMENT



ELECTRIC ONLY

1. RIO / RIO WIFI'S CONNECTION AND COUPLING
 - a. Insert RIO / RIO WIFI into the electric heating element connection, applying slight pressure until RIO / RIO WIFI is fully inserted.
 - b. Keep RIO / RIO WIFI pressed against the heating element in the towel rail and insert the provided grub screw into its spot; make sure there is no room between the device and the electric heating element fixing part (see part 3).

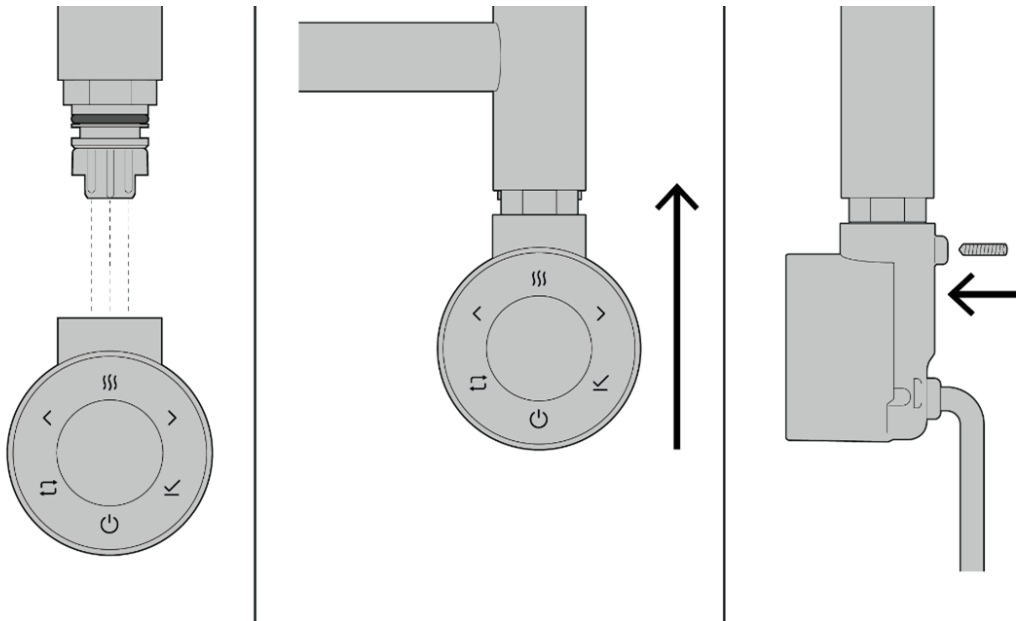

2. GRUB SCREW INSERTION

- a. Keeping RIO / RIO WIFI pressed against the heating element in the towel rail, make sure the grub screw is in its right positioning spot (grub screw seat) as shown in figure below.
- b. Using the provided Allen key tighten the grub screw until it comes into contact and it is fully inserted in its spot, so that the RIO / RIO WIFI is securely fixed to the electric heating element and the O-ring gasket is well in contact with both surfaces
- c. Make sure the grub screw is NOT in other wrong positions by checking the alignment with the back of RIO / RIO WIFI, as shown in figure below.

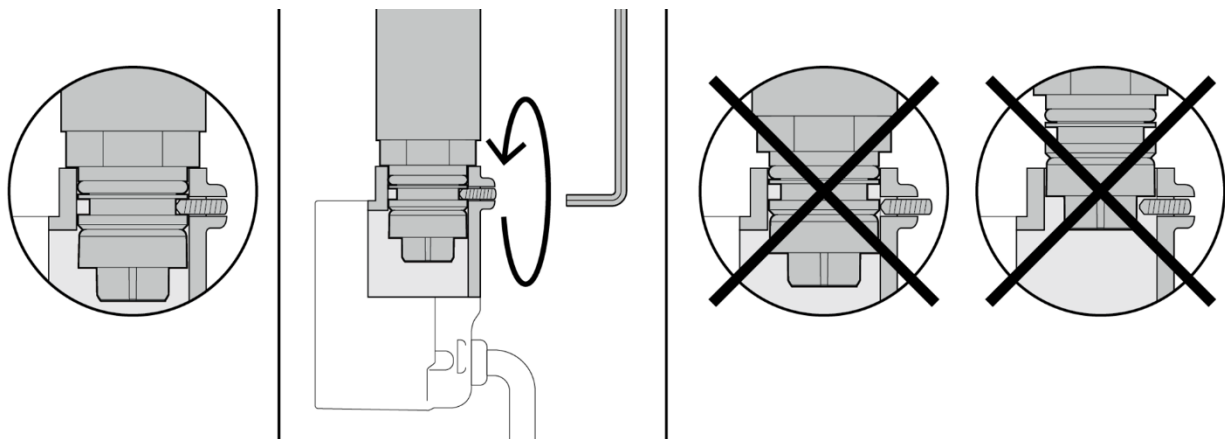

3. TOWEL RAIL INSTALLATION

If the display is facing the wall after tightening the heater, always adjust the heating element by turning it anti-clockwise with the 25mm spanner. The seal is designed to adjust to a certain amount of releasing without starting to leak.

- Install properly the electrified towel rail with the RIO / RIO WIFI into the wall according to towel rail manufacturer instructions (See part 5.2).

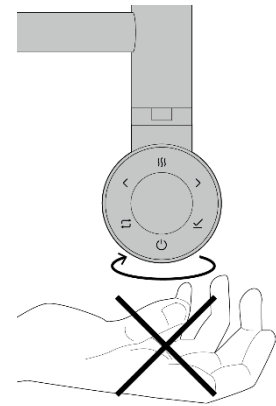

4. CONNECTION TO THE MAINS

- a. Connect the RIO / RIO WIFI cable to the mains power according to current wiring regulations in force in the country where the product is installed. Make sure that the power lines are appropriate for the load required.
- b. Check electric strength on the appliance after fitting RIO / RIO WIFI to the electric towel rail according to the instructions in Appendix A of EN60335-1: "Routine tests".
- c. In case of *Class I* controls, check earthing continuity on the appliance after fitting RIO / RIO WIFI to the electric towel rail according to the instructions in Appendix A of EN60335-1: "Routine tests".

5.5.2 IF RIO / RIO WIFI INCL. HEAT. ELEMENT IS NOT CONNECTED TO THE TOWEL RAIL



DUEL-FUEL

VERIFICATIONS BEFORE INSTALLATION

- Check the package delivery.
- The delivery includes a radiator, a heating element with a protected Nexus connector and a RIO / RIO WIFI controller.
- The heating element is pre-prepared in the radiator bus, it is not properly installed.
- Carefully unscrew it and prepare it for proper installation.
- Switch off the mains.
- Do not connect RIO / RIO WIFI to the power supply until the installation into a properly filled towel rail is completed.
- Make sure that the towel rail can have the RIO / RIO WIFI on the bottom side (Figure 5).
- If the heating element or the controller is damaged, do not continue with the installation, please contact the seller.

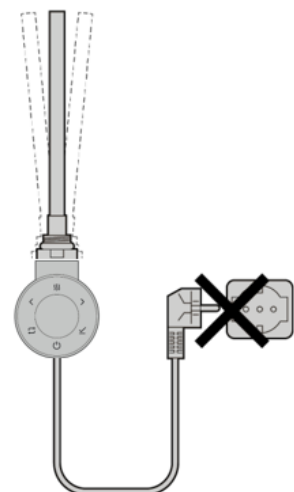

INSTALLING THE HEATING ELEMENT IN THE TOWEL RAIL

- Unscrew the heating element from the towel rail with a light rotary movement. Remove the Nexus connector cover.
- Insert the supplied RIO / RIO WIFI O-ring gasket from the bottom over the heating element in the reserved space.
In order to minimize the risk for leakage it is recommended to use a PTFE tape or similar product to prevent leakage.
- Insert the tip of the heating element into the bottom hole of the towel rail and make sure to select the female ½" GAS thread.).
- Insert the heating element all the way in the upside down radiator and screw in the heating element using a 25 mm wrench (not included).

In case of 'Dual fuel' installation, a T-piece of 40 mm maximum length (male thread excluded) is sometimes required.

Insert the T-piece in the heating element, screw and tighten it firmly. Do not use tools.

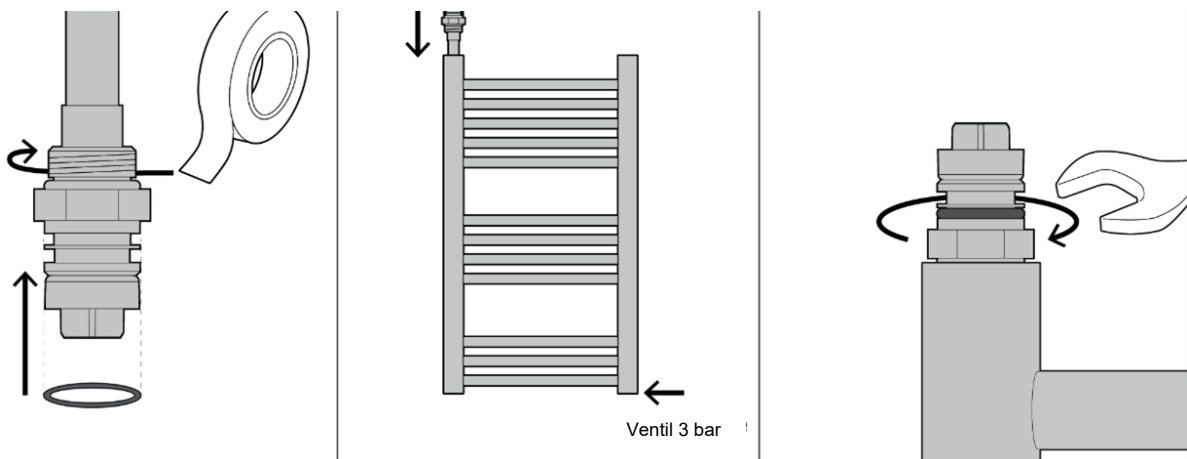

WHEN THE HEATING ELEMENT IS CONNECTED TO THE TOWEL RAIL, GO TO 5.5.1

5.6 Cleaning

To clean RIO / RIO WIFI, use only a dry and clean soft cloth.

Make small locally round movements.

Apply a light pressure especially to the chrome plastic surfaces to avoid potential scratches.

Do not clean RIO / RIO WIFI with aggressive products.

Do not wet RIO / RIO WIFI in an attempt to clean it. Do not immerse in water.

When cleaning RIO / RIO WIFI, it must be disconnected from the power supply.

5.7 Uninstalling RIO / RIO WIFI

ALL ELECTRICAL WORK SHOULD BE CARRIED OUT BY A QUALIFIED ELECTRICIAN.

Do not touch the metallic parts of RIO / RIO WIFI if it is powered; before maintenance and de-installation operation wait the necessary time to ensure it is cold after it is switched off.

During installation, de-installation and maintenance, ensure working place safety until the operation is completed.

5.8 Notes for disposal of RIO / RIO WIFI valid for the European Union



The crossed-out wheeled-bin symbol on the towel rail to which RIO / RIO WIFI is installed, reminds you that in the European Union all electrical and electronic products and batteries must be taken to separate collection at the end of their working life. Do not dispose of these products as unsorted municipal waste. Return

the products to collection to prevent possible harm to the environment or human health from uncontrolled waste disposal and to promote the sustainable reuse of material resources. Collection information is available from the product retailer, local waste authorities or national producer responsibility organizations. For more information, see product country-specific information.

6 USE AND FUNCTIONING

All uses different from the ones described in this section are to be intended as improper usage. In case of doubts refer to the seller.

- The electrical towel rail with regulator is intended only for heating rooms in the home. Any other use is forbidden.
- RIO / RIO WIFI is intended to be used and installed into a towel rail. Any other use is strictly forbidden and potentially dangerous.
- do not switch on RIO / RIO WIFI unless the heating element is properly immersed in the liquid inside the towel rail.
- RIO / RIO WIFI is intended to work only if the electric heating element - connected to RIO / RIO WIFI and fitted into the towel rail - is completely immersed in the liquid (water) inside the towel rail.
- RIO / RIO WIFI is designed for use with water or water+glycol filled towel rails.
- Do not use RIO / RIO WIFI before it has been completely and correctly installed. If RIO / RIO WIFI is not firmly fixed to the towel rail, disconnect the mains turning off the circuit breaker switch and contact the manufacturer in order to avoid hazard.
- Do not cut the power supply cable to stop regulation or to switch RIO / RIO WIFI OFF.
- Once connected to the heating element, RIO / RIO WIFI regulating box **MUST NOT** be disconnected from the heating element.
- Do not cover RIO / RIO WIFI, even partially, even temporarily.

7 CONTROLLER FUNCTIONS

7.1 RIO / RIO WIFI buttons maps

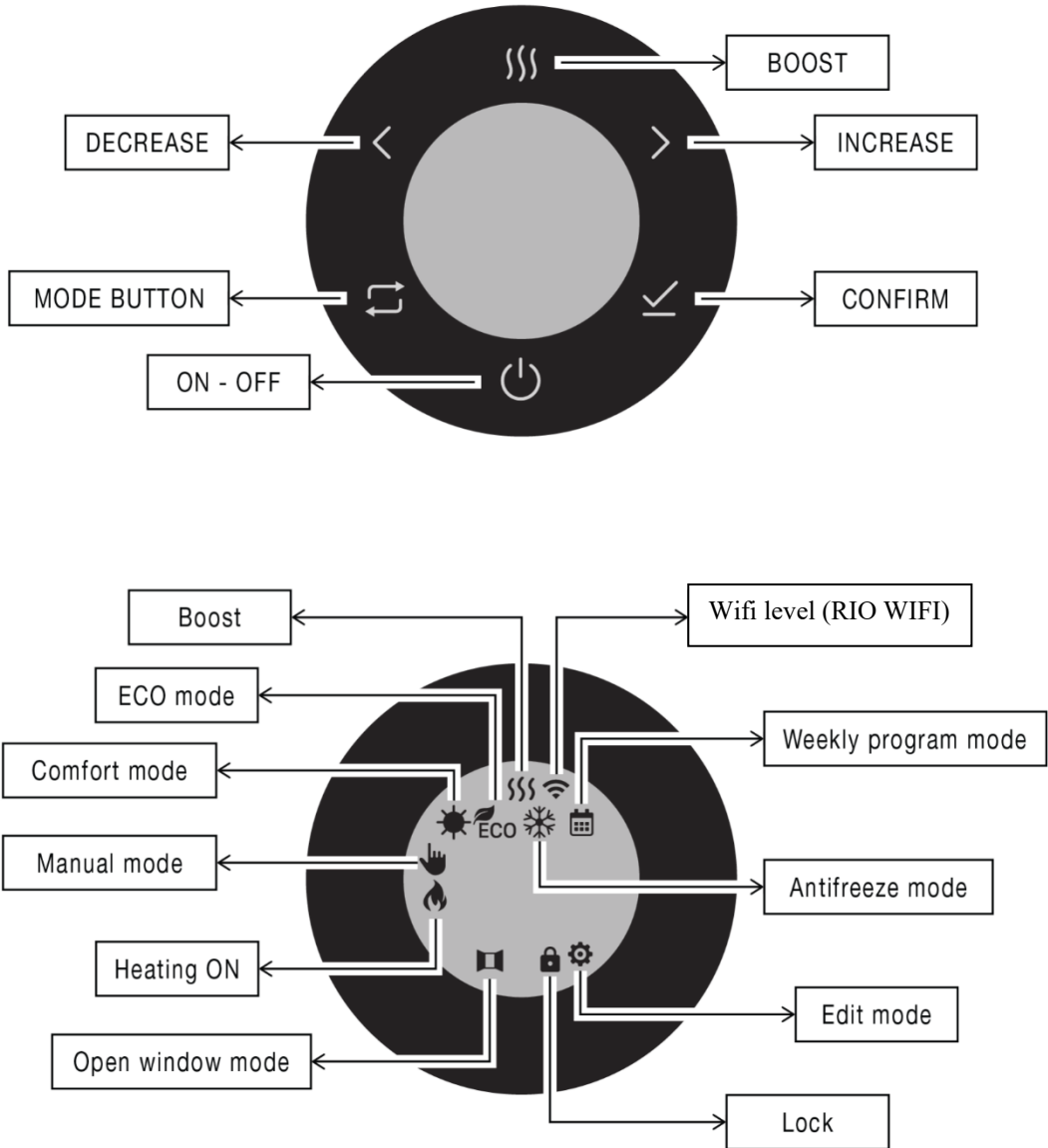

Short press



Long press

7.2 First start

First start	Set Hour, Minute and Day.
-------------	---------------------------

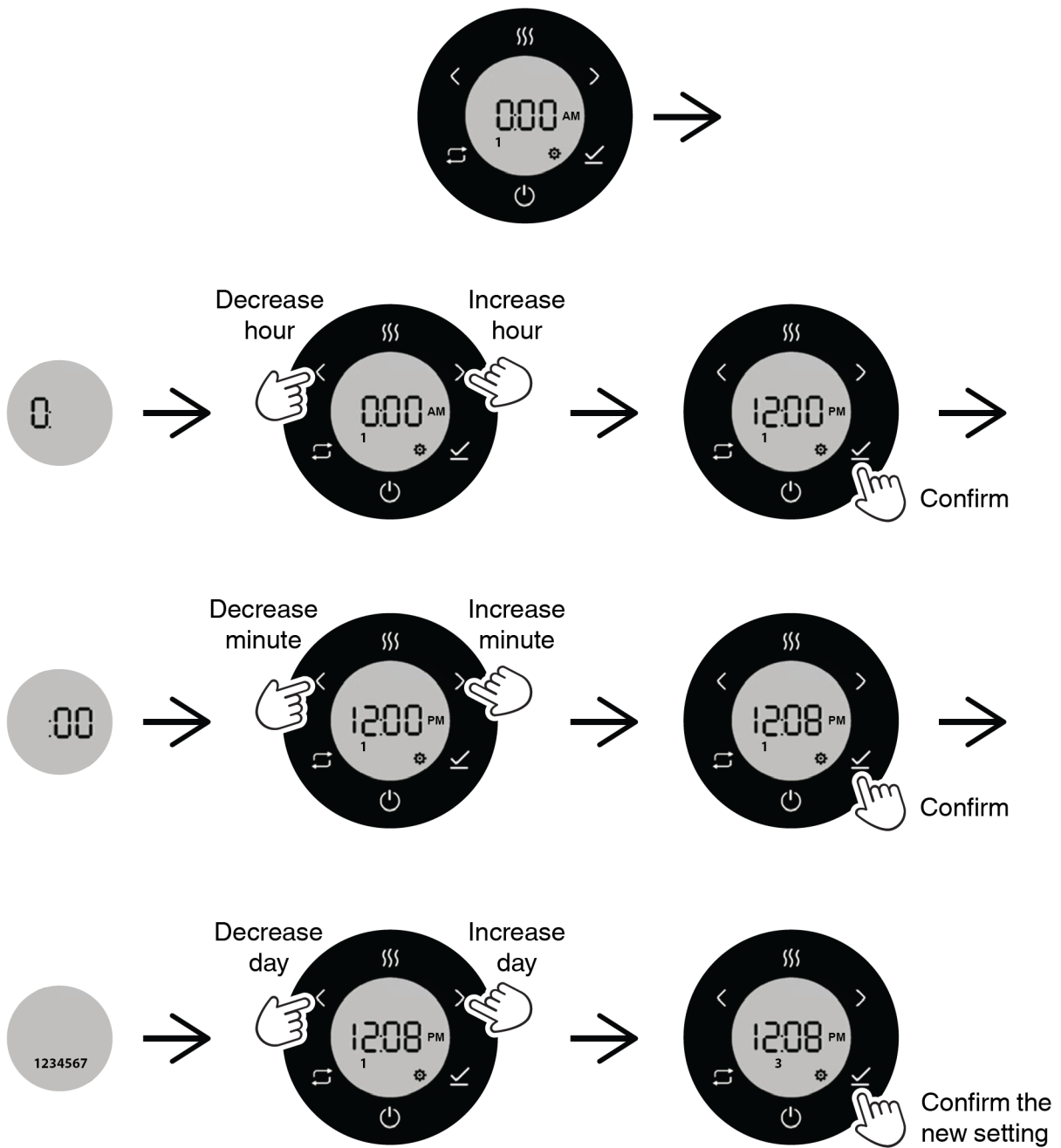

7.3 Standard functions ON-OFF

Display backlight	Tap any button one time to turn on the display from the stand-by mode (display off). Display will light on.
Backlight for the display: off after 5 second and on when a button is touched.	

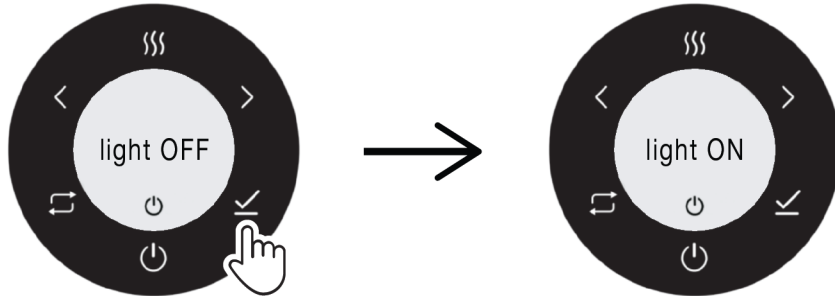

ON	<p>Backlight on: Tap ON-OFF button to switch on the controller.</p> <p>Backlight off: Tap any button to switch on the backlight then tap ON-OFF button to switch on the controller.</p>
-----------	---

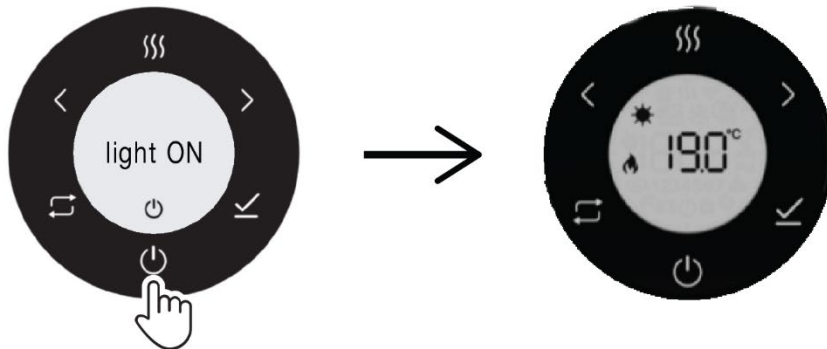

OFF	<p>Backlight on: Tap ON-OFF button to switch off the controller.</p> <p>Backlight off: Tap any button to switch on the backlight then tap ON-OFF button to switch off the controller.</p>
------------	---



7.4 Mode selection

Display backlight	Tap any button one time to turn on the display from the stand-by mode (display off). Display will light on.
ON	Tap ON-OFF button to switch on the controller

Mode button	To switch between the operating modes.
--------------------	--

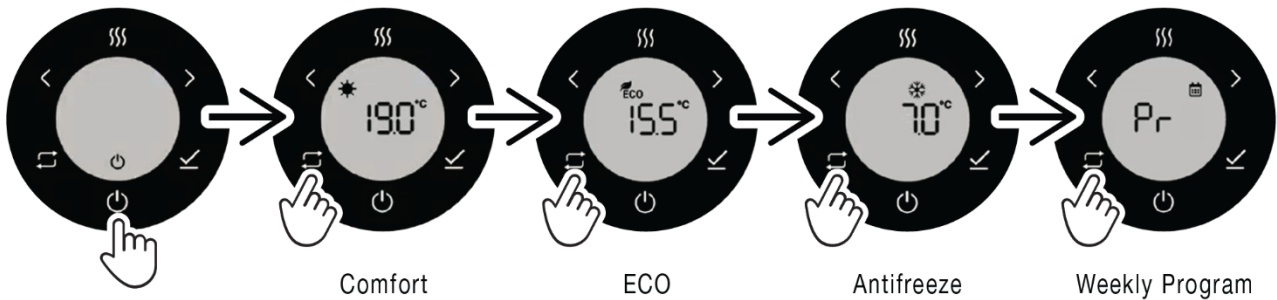

Mode	Temperature setting
Comfort	17-25 ° C
ECO	14-19 ° C
Antifreeze	7-15 ° C

7.5 Mode editing

Display backlight	Tap any button one time to turn on the display from the stand-by mode (display off). Display will light on.
ON	Tap ON-OFF button to switch on the controller

Mode button	To switch between the operating modes.
--------------------	--

SELECT the mode (comfort / eco / antifreeze) you want to edit as shown in mode selection

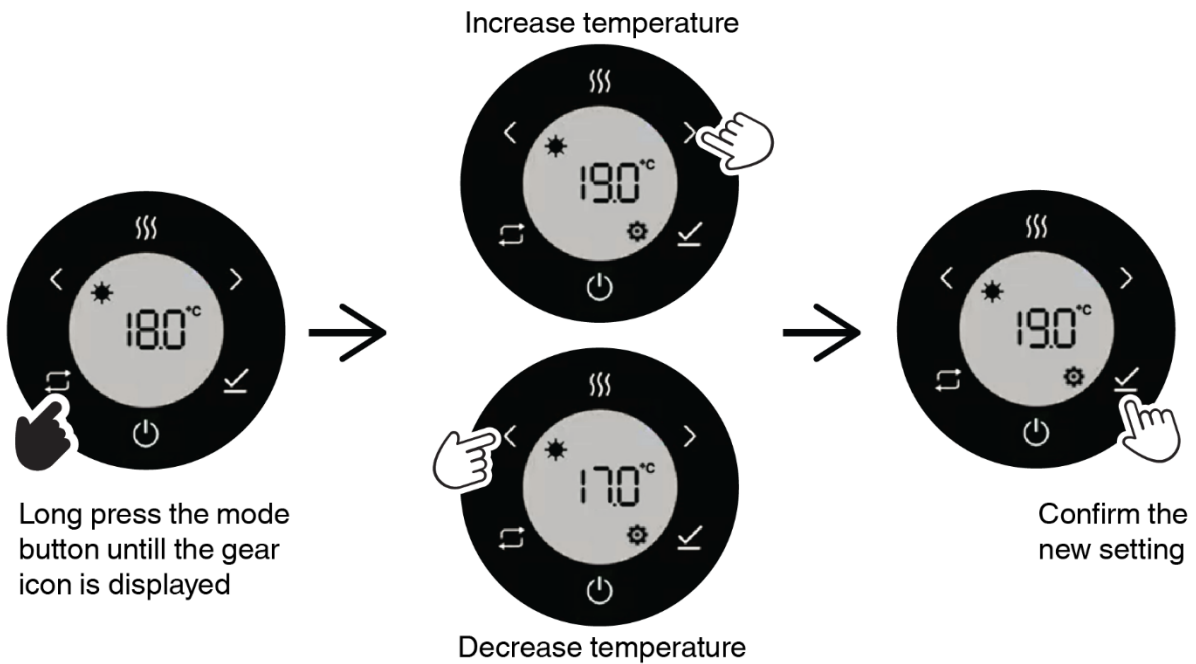

7.6 Boost mode

Display backlight	Tap any button one time to turn on the display from the stand-by mode (display off). Display will light on.
ON	Tap ON-OFF button to switch on the controller

Boost / Dryer	Select Boost in order to work at maximum heating level. Tap > or < to customize the time. After the time selected the controller will automatically stop heating and continue to the previous mode.
Time setting: From 60 minutes to 240 minutes	

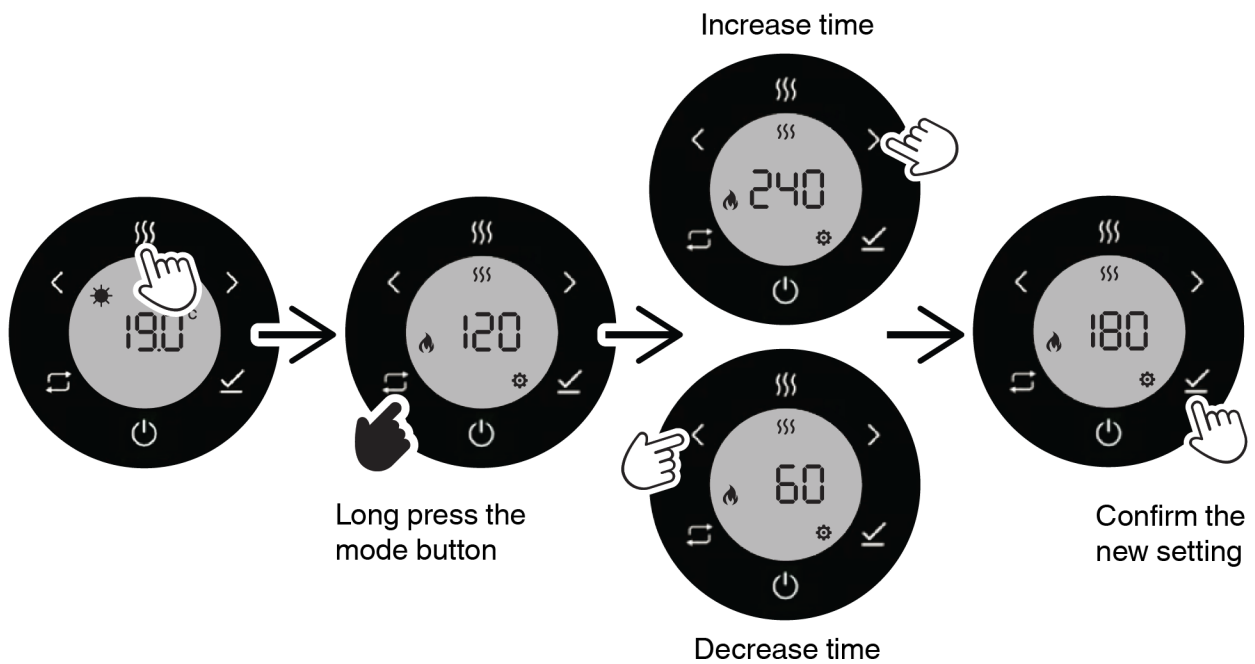

7.7 Weekly program edit

Display backlight	Tap any button one time to turn on the display from the stand-by mode (display off). Display will light on.
ON	Tap ON-OFF button to switch on the controller

Mode button	Tap mode button to reach the operating modes Weekly Program
<p>If you don't press any button for 3 minutes the timing process program will exit without saving. To save your changes please follow the steps until the last day of the week with the 24 complete hours.</p>	

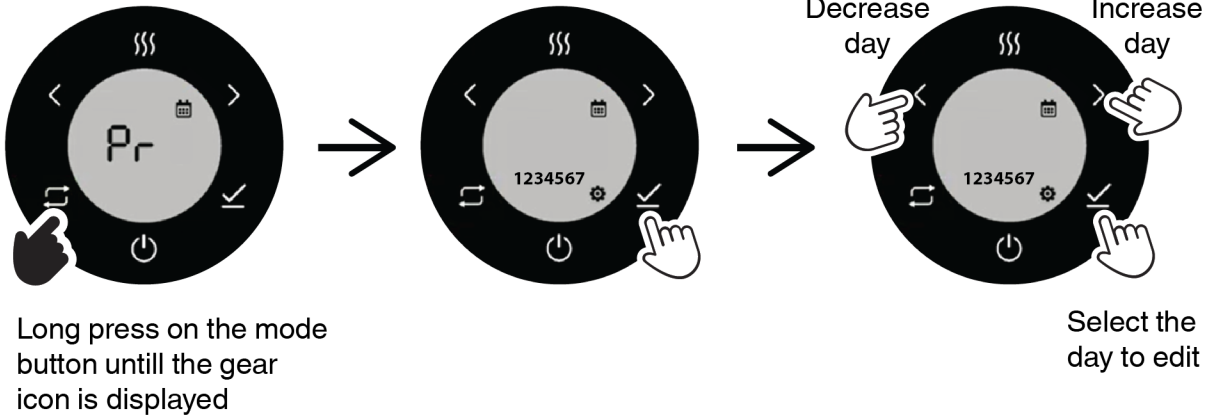

The timing process is completed when you have edited the 24 hours

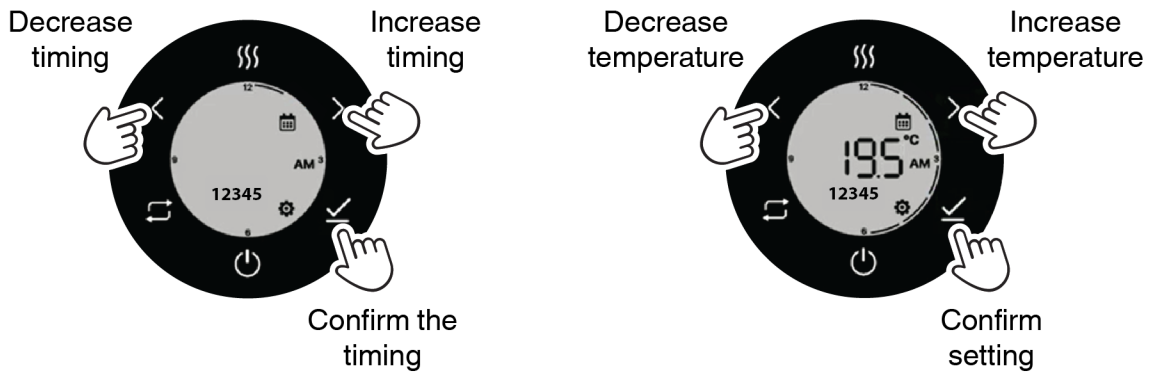

 Repeat to complete all days

Please note that it is possible to add up to 14 temperature set point each day.

7.8 Weekly program view

Display backlight	Tap any button one time to turn on the display from the stand-by mode (display off). Display will light on.
ON	Tap ON-OFF button to switch on the controller
Mode button	Tap mode button to reach the operating modes Weekly Program

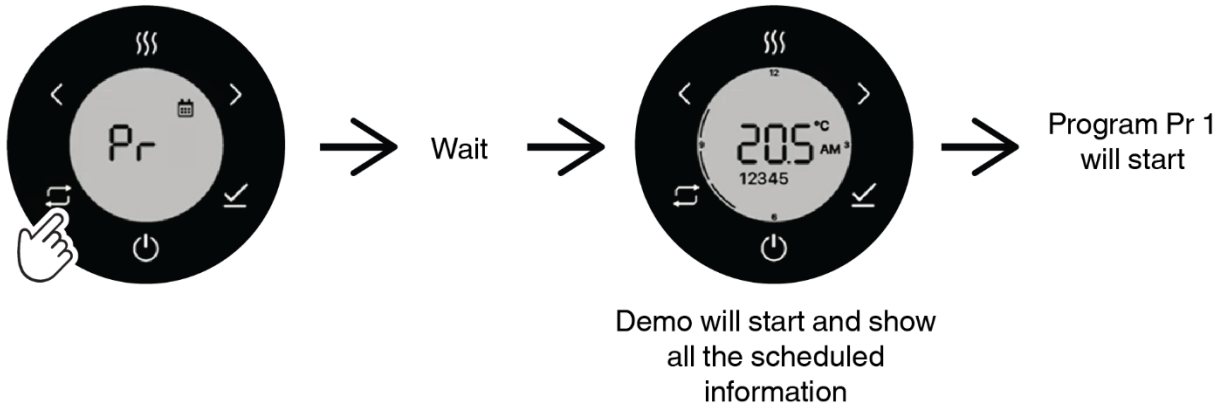

7.9 Secondary functions

Mode button	To switch between the secondary functions.
Long press the mode (Open window / Timing / Application / Temperature display / Factory reset) you want to edit as shown in next points	

Note: Functions Application and Temperature display are for WiFi version only.

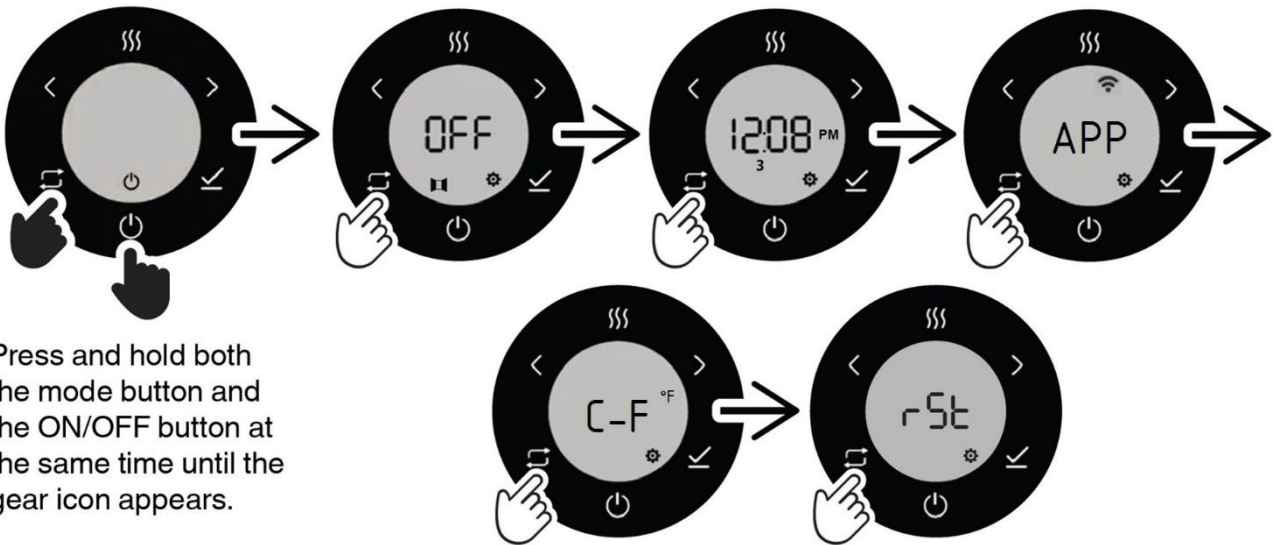

7.9.1 Open window

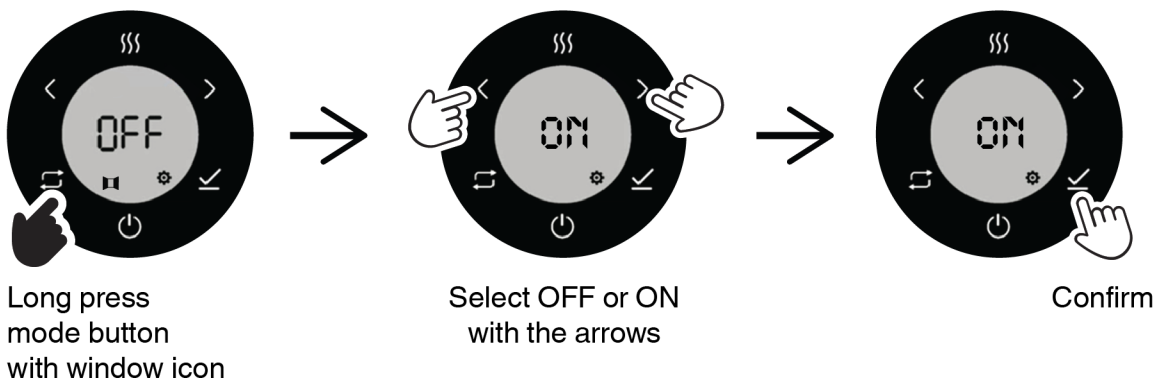

7.9.2 Timing

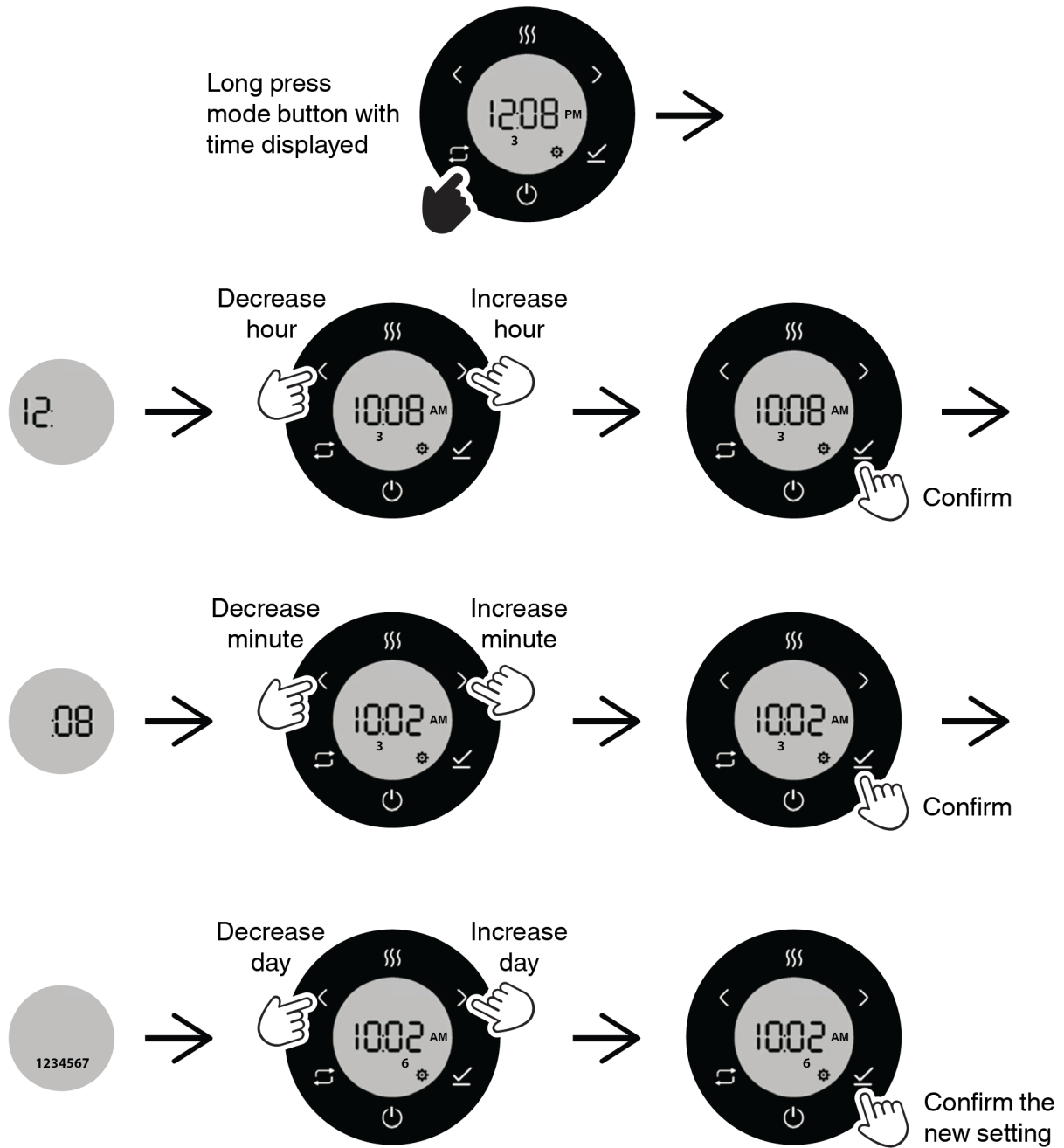

7.9.3 Factory reset

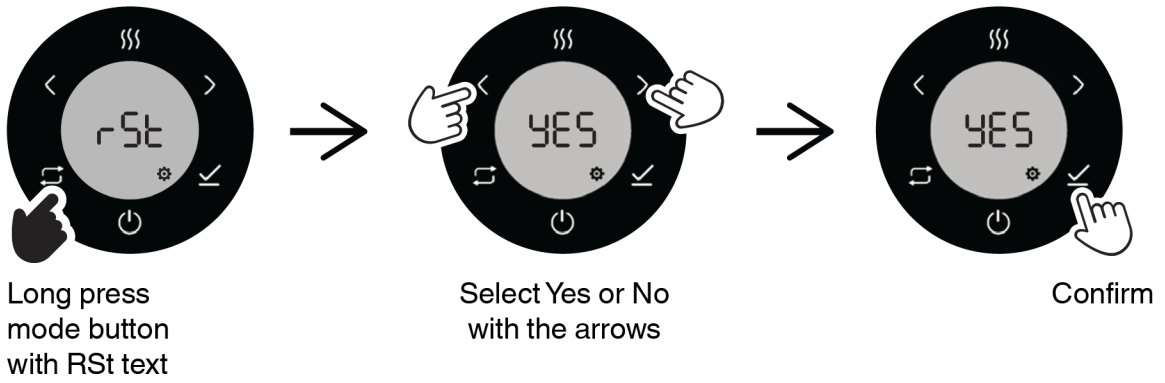

7.10 Lock

Lock function	Disable all the buttons.
Long press the ON/OFF button while in Comfort / Eco / Antifreeze mode to activate the lock function.	

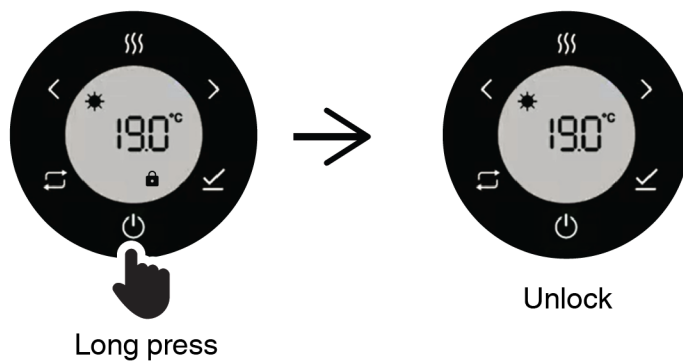
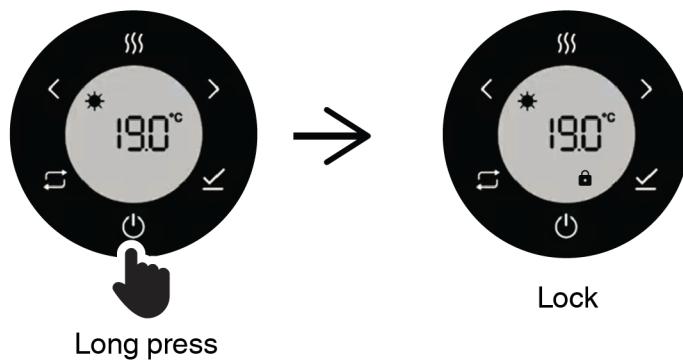

7.11 WIFI connection (RIO WIFI)

WIFI function	RIO WIFI can be managed using the App through the WIFI
Connection with smart device via 2.4 GHz WIFI	

Download the **Stone Connect Wi-Fi App**



, open it and register (if necessary) or enter as a guest.

This App includes a guided installation menu and provides instructions for putting the RIO WIFI in pairing mode (search for Smart Device that can accept the connection via WIFI).

Access the WIFI menu and follow the indications provided by the App.

A screenshot of the registration form in the app. It has a dark background with white text and input fields. The fields are labeled: Name, Surname, Email, Password, and Confirm password. Below the fields are two buttons: REGISTER and CANCEL.A screenshot of the 'Mode settings' screen. It shows four colored icons (blue, green, orange, pink) at the top. Below them is the text 'ANTIFREEZE'. In the center, there is a large circular graphic with a leaf icon and the number '11,0'. At the bottom is a CONFIRM button.A screenshot of the 'Scheduler' screen. It shows a weekly temperature schedule for 'Zona: Bathroom'. The days of the week are listed at the top, with 'Fr' (Friday) selected. Below each day, there are time slots and temperatures: 'from 00:00 18,0°', 'from 06:30 21,0°', 'from 08:30 18,0°', 'from 19:30 22,0°', and 'from 23:00 20,0°'. There are also buttons for 'COPY FRIDAY', '+', and '-'. A CONFIRM button is at the bottom.

Registration or Login.

Select your working mode or program your week.

Set the desired temperature in your weekly program.

8 MAINTENANCE

Switch off the mains before any installation, de-installation or maintenance operation on RIO / RIO WIFI.

- During installation, de-installation and maintenance, ensure working place safety until the operation is completed.
IMPORTANT: Always disconnect the electricity supply from the mains during installation and maintenance. It is recommended that the fuse is withdrawn or circuit breaker switched off at the distribution board while work is in progress (turning off the switch is not sufficient).
- Never try to modify or repair the RIO / RIO WIFI in any of its parts by yourself. Never try to remove any part of the RIO / RIO WIFI as water can penetrate inside the regulation box resulting in a risk of electrical shock. Never knock the RIO / RIO WIFI against anything. Handle with extreme care during every operation and never leave it in wet areas.

9 DIAGNOSTICS

Description of fault	Operations
RIO / RIO WIFI regulation mode is selected at maximum power level and the towel rail doesn't heat at all	The product must be replaced, please contact seller.
LEDs are ON but the towel rail doesn't heat	<ul style="list-style-type: none">• Wait for 2 hours• If the situation doesn't change, contact the seller
In case of anomalous or strange working condition or if RIO / RIO WIFI has visible signs of damage	<ul style="list-style-type: none">• Disconnect the RIO / RIO WIFI from the mains• switch off the omnipolar switch immediately• send RIO / RIO WIFI to the seller for investigation or replacement.

10 SUPPLIED ACCESSORIES, CONSUMABLES AND SPARE PARTS

In the event of malfunctioning or damage, the whole RIO / RIO WIFI must be replaced. No spare parts are available. If the RIO / RIO WIFI regulating box shows some plastic cracks, please contact the seller for replacement.

RIO / RIO WIFI power supply cable cannot be repaired. If it is damaged, it must be replaced by the manufacturer, its service agent or similarly qualified persons in order to

avoid a hazard. Never try to modify or repair the RIO / RIO WIFI in any of its parts by yourself. Never try to remove any part of the RIO / RIO WIFI as water can penetrate inside the regulation box resulting in a risk of electrical shock. Never knock the RIO / RIO WIFI against anything. Handle with extreme care during every operation and never leave it in wet areas.

11 POWER CABLE REDUCTION

The length of the power supply cable RIO / RIO WIFI can be reduced to allow its direct installation in a wall box or connection to a terminal designed for the cable, i.e. it is certified and rated for the given type of installation (e.g. an electric plug with an integrated switch).

CAUTION! The cable must extend at least 300 mm from the inlet to the heating unit, the thermostat receiver or regulator (according to the equipment installed) after it has been cut. No warranty claim or repair will be accepted, including defects not related to the shortening of the cable, if the length of the cable is less than 300 mm.

The reduction may only be carried out by a person with the appropriate electrical expertise! The external insulation of the cable and the insulation of individual conductors must remain intact. Avoid using cables with broken insulation.

All connections/wiring must be in compliance with the legislation of the country where the installation is performed, as well as with the rules for use in specific environments (e.g. bathrooms), the IEC 60364-7-701 standard in particular.

In this case, the rated degree of protection, IPX4, as declared by the manufacturer of the product, will not apply to the reduced end of the cable and/or any terminal.

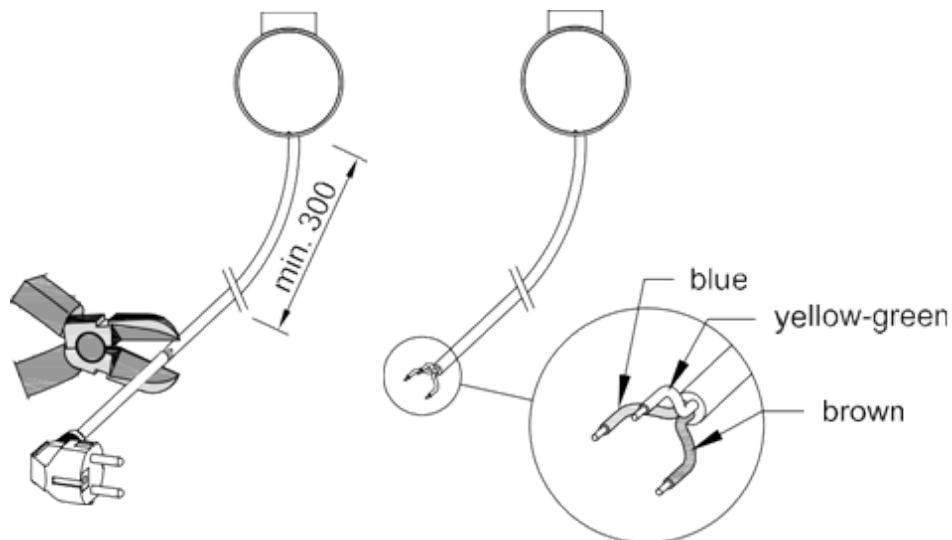

The wiring of Class I equipment is as follows:

Brown (black):	L	phase 230 V / 50 Hz
Blue:	N	neutral conductor
Yellow-green:	PE	protective conductor (earth)

The manufacturer assumes no responsibility for any damage to the equipment or personal injury caused by improper installation of the cable, reversed polarity, insulation damage or any other intervention, connection or wiring that is not in compliance with the applicable regulations.



01/24 800341185_EN_QR